

Data sheet | Item number: 765-1705/200-000

8-channel digital input/output; IO Link Class B Server Hub; 8 Configurable DIO; DC 24 V / 2.0 A; 8xM8 connection; HubLine

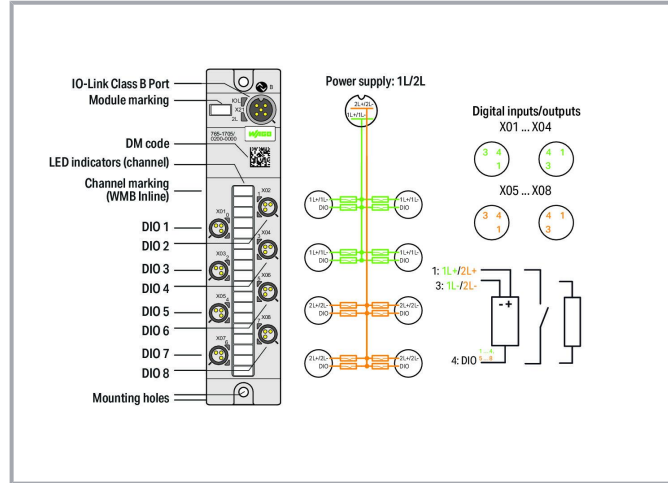

www.wago.com/765-1705_200-000



Data

Technical data

IO-Link

Communication	IO-Link
Connection technology: communication/fieldbus	1 x A-coded M12; 5-pole

Device Functions

Parameter	Input filter Output current Temperature
Diagnostics	Undervoltage; Overcurrent; Overload; Overtemperature

Digital inputs/outputs

Number of digital inputs	8
--------------------------	---

Subject to changes. Please also observe the further product documentation!

WAGO Corporation
 Germantown, WI 53022
 Phone: 1-800-DIN-RAIL (346-7245) | Fax: (262) 255-6222
 Email: info.us@wago.com | Web: www.wago.us

Do you have any questions about our products?
 We are always happy to take your call at (262) 255-6222 or 1 800-DIN-RAIL.



Number of digital outputs	8
Connection technology: inputs / outputs	8 x M8; 3-pole
Voltage signal type	DC 24 V
Input characteristic	High-side switching
Input filter	0.2 ... 20 ms
Input characteristic	Type 3, per IEC 61131-2
Output current (per channel)	2 A

Power Supply

Connection technology: supply	1 x A-coded M12; 5-pole; via IO-Link port (1L/2L)
Supply voltage	24 VDC (18 ... 31.2 V); 1L/2L
Power consumption (max.)	4000 mA
Power consumption (note)	1L: 0.2 A; 2L: 0.1 A; + load current
Reverse voltage protection	Yes

Geometrical Data

Width	35 mm / 1.378 inch
Height	30 mm / 1.181 inch
Depth	158.5 mm / 6.24 inch

Mechanical Data

Weight	120 g
Conformity marking	CE

Environmental Requirements

Surrounding air temperature (operation)	-25 ... 70 °C
Surrounding air temperature (storage)	-40 ... 80 °C
Protection type	IP67
Protection class	III per EN 61140, IEC 61140, VDE 0140-1
Operating altitude	0 ... 2000 m
Pollution degree (5)	3 per EN 60664-1
Overvoltage category	II (EN 60664-1)
Vibration resistance	5g per IEC 60068-2-6
Shock resistance	Short-term: 50g/11 ms/half-sine per IEC 60068-2-27; Long-term: 30g/6 ms/half-sine per IEC 60068-2-29
EMC immunity to interference	per EN 61000-6-2
EMC emission of interference	per EN 61000-6-4

Subject to changes. Please also observe the further product documentation!

WAGO Corporation
 Germantown, WI 53022
 Phone: 1-800-DIN-RAIL (346-7245) | Fax: (262) 255-6222
 Email: info.us@wago.com | Web: www.wago.us

Do you have any questions about our products?
 We are always happy to take your call at (262) 255-6222 or 1 800-DIN-RAIL.

Commercial data

Packaging type	BOX
Country of origin	DE
GTIN	4055143949781
Customs tariff number	8537109170

Required accessories



Tools

	Item no.: 206-701 Torque wrench M8 and M12; Assembly kit	www.wago.com/206-701
--	--	--

Cover





	Item no.: 756-8101 M8 protective cap; for unused sockets	www.wago.com/756-8101
	Item no.: 756-8103 M12 protective cap; for unused plugs	www.wago.com/756-8103

Marking accessories

	Item no.: 2009-110 Marking strips; for Smart Printer; on reel; not stretchable; plain; snap-on type; white	www.wago.com/2009-110
	Item no.: 2009-115 WMB-Inline; for Smart Printer; 1500 pieces on roll; stretchable 5 - 5.2 mm; plain; snap-on type; white	www.wago.com/2009-115

Optional accessories

Cables and pluggable connectors

	Item no.: 756-5111/030-015 Sensor/Actuator cable; M8 plug; straight; 3-pole; Length: 1.5 m	www.wago.com/756-5111/030-015
	Item no.: 756-5111/030-050 Sensor/Actuator cable; M8 plug; straight; 3-pole; Length: 5 m	www.wago.com/756-5111/030-050
	Item no.: 756-5111/030-100 Sensor/Actuator cable; M8 plug; straight; 3-pole; Length: 10 m	www.wago.com/756-5111/030-100
	Item no.: 756-5112/030-015 Sensor/Actuator cable; M8 plug; angled; 3-pole; Length: 1.5 m	www.wago.com/756-5112/030-015

Subject to changes. Please also observe the further product documentation!

WAGO Corporation
 Germantown, WI 53022
 Phone: 1-800-DIN-RAIL (346-7245) | Fax: (262) 255-6222
 Email: info.us@wago.com | Web: www.wago.us

Do you have any questions about our products?
 We are always happy to take your call at (262) 255-6222 or 1 800-DIN-RAIL.



✓	Item no.: 756-5112/030-050 Sensor/Actuator cable; M8 plug; angled; 3-pole; Length: 5 m	www.wago.com/756-5112/030-050
✓	Item no.: 756-5112/030-100 Sensor/Actuator cable; M8 plug; angled; 3-pole; Length: 10 m	www.wago.com/756-5112/030-100
⊖	Item no.: 756-5201/030-010 Sensor/Actuator cable; M8 socket; straight; M8 plug; straight; 3-pole; Length: 1 m	www.wago.com/756-5201/030-010
⊖	Item no.: 756-5201/030-020 Sensor/Actuator cable; M8 socket; straight; M8 plug; straight; 3-pole; Length: 2 m	www.wago.com/756-5201/030-020
⊖	Item no.: 756-5202/030-010 Sensor/Actuator cable; M8 socket; straight; M8 plug; angled; 3-pole; Length: 1 m	www.wago.com/756-5202/030-010
⊖	Item no.: 756-5202/030-020 Sensor/Actuator cable; M8 socket; straight; M8 plug; angled; 3-pole; Length: 2 m	www.wago.com/756-5202/030-020
⊖	Item no.: 756-5203/030-010 Sensor/Actuator cable; M8 socket; angled; M8 plug; straight; 3-pole; Length: 1 m	www.wago.com/756-5203/030-010
⊖	Item no.: 756-5203/030-020 Sensor/Actuator cable; M8 socket; angled; M8 plug; straight; 3-pole; Length: 2 m	www.wago.com/756-5203/030-020
⊖	Item no.: 756-5204/030-010 Sensor/Actuator cable; M8 socket; angled; M8 plug; angled; 3-pole; Length: 1 m	www.wago.com/756-5204/030-010
⊖	Item no.: 756-5204/030-020 Sensor/Actuator cable; M8 socket; angled; M8 plug; angled; 3-pole; Length: 2 m	www.wago.com/756-5204/030-020
✓	Item no.: 756-5301/050-015 Sensor/Actuator cable; M12A socket; straight; 5-pole; Length: 1.5 m	www.wago.com/756-5301/050-015
✓	Item no.: 756-5301/050-050 Sensor/Actuator cable; M12A socket; straight; 5-pole; Length: 5 m	www.wago.com/756-5301/050-050
✓	Item no.: 756-5301/050-100 Sensor/Actuator cable; M12A socket; straight; 5-pole; Length: 10 m	www.wago.com/756-5301/050-100









Subject to changes. Please also observe the further product documentation!



✓	Item no.: 756-5302/050-015 Sensor/Actuator cable; M12A socket; angled; 5-pole; Length: 1.5 m	www.wago.com/756-5302/050-015
✓	Item no.: 756-5302/050-050 Sensor/Actuator cable; M12A socket; angled; 5-pole; Length: 5 m	www.wago.com/756-5302/050-050
✓	Item no.: 756-5302/050-100 Sensor/Actuator cable; M12A socket; angled; 5-pole; Length: 10 m	www.wago.com/756-5302/050-100
⊖	Item no.: 756-5401/050-010 Sensor/Actuator cable; M12A socket; straight; M12A plug; straight; 5-pole; Length: 1 m	www.wago.com/756-5401/050-010
⊖	Item no.: 756-5401/050-020 Sensor/Actuator cable; M12A socket; straight; M12A plug; straight; 5-pole; Length: 2 m	www.wago.com/756-5401/050-020
⊖	Item no.: 756-5402/050-010 Sensor/Actuator cable; M12A socket; straight; M12A plug; angled; 5-pole; Length: 1 m	www.wago.com/756-5402/050-010
⊖	Item no.: 756-5402/050-020 Sensor/Actuator cable; M12A socket; straight; M12A plug; angled; 5-pole; Length: 2 m	www.wago.com/756-5402/050-020
⊖	Item no.: 756-5403/050-010 Sensor/Actuator cable; M12A socket; angled; M12A plug; straight; 5-pole; Length: 1 m	www.wago.com/756-5403/050-010
⊖	Item no.: 756-5403/050-020 Sensor/Actuator cable; M12A socket; angled; M12A plug; straight; 5-pole; Length: 2 m	www.wago.com/756-5403/050-020
⊖	Item no.: 756-5404/050-010 Sensor/Actuator cable; M12A socket; angled; M12A plug; angled; 5-pole; Length: 1 m	www.wago.com/756-5404/050-010
⊖	Item no.: 756-5404/050-020 Sensor/Actuator cable; M12A socket; angled; M12A plug; angled; 5-pole; Length: 2 m	www.wago.com/756-5404/050-020
⊖	Item no.: 756-5501/030-010 Sensor/Actuator cable; M12A socket; straight; M8 plug; straight; 3-pole; Length: 1 m	www.wago.com/756-5501/030-010
⊖	Item no.: 756-5501/030-020 Sensor/Actuator cable; M12A socket; straight; M8 plug; straight; 3-pole; Length: 2 m	www.wago.com/756-5501/030-020

Subject to changes. Please also observe the further product documentation!



	<p>Item no.: 756-5502/030-010 Sensor/Actuator cable; M12A socket; straight; M8 plug; angled; 3-pole; Length: 1 m</p>	<p>www.wago.com/756-5502/030-010</p>
	<p>Item no.: 756-5502/030-020 Sensor/Actuator cable; M12A socket; straight; M8 plug; angled; 3-pole; Length: 2 m</p>	<p>www.wago.com/756-5502/030-020</p>
	<p>Item no.: 756-5503/030-010 Sensor/Actuator cable; M12A socket; angled; M8 plug; straight; 3-pole; Length: 1 m</p>	<p>www.wago.com/756-5503/030-010</p>
	<p>Item no.: 756-5503/030-020 Sensor/Actuator cable; M12A socket; angled; M8 plug; straight; 3-pole; Length: 2 m</p>	<p>www.wago.com/756-5503/030-020</p>
	<p>Item no.: 756-5504/030-010 Sensor/Actuator cable; M12A socket; angled; M8 plug; angled; 3-pole; Length: 1 m</p>	<p>www.wago.com/756-5504/030-010</p>
	<p>Item no.: 756-5504/030-020 Sensor/Actuator cable; M12A socket; angled; M8 plug; angled; 3-pole; Length: 2 m</p>	<p>www.wago.com/756-5504/030-020</p>
	<p>Item no.: 756-9102/030-000 Accessories; 3-pole</p>	<p>www.wago.com/756-9102/030-000</p>
	<p>Item no.: 756-9105/030-000 Accessories; 3-pole</p>	<p>www.wago.com/756-9105/030-000</p>

**Downloads
Documentation**

Manual

<p>8-Channel Digital Input/Output; IO Link Class B Hub DC 24 V / 2.0 A; 8xM8 Connection; HubLine</p>	<p>V 1.1.0 Nov 30, 2020</p>	<p>pdf 2.8 MB</p>	<p>Download</p>
--	---------------------------------	-----------------------	-----------------

System Description

<p>WAGO I/O System Field; General Product Information</p>	<p>pdf 708.2 kB</p>	<p>Download</p>
---	-------------------------	-----------------

Engineering-Software

WAGO IO-Link Configurator

Subject to changes. Please also observe the further product documentation!

WAGO Corporation
Germantown, WI 53022
Phone: 1-800-DIN-RAIL (346-7245) | Fax: (262) 255-6222
Email: info.us@wago.com | Web: www.wago.us

Do you have any questions about our products?
We are always happy to take your call at (262) 255-6222 or 1 800-DIN-RAIL.

Data sheet | Item number: 765-1705/200-000

www.wago.com/765-1705_200-000



WAGO IO-Link Configurator

V5.1.1
Dec 17, 2020

ZIP
25.2 MB

[Download](#)

The WAGO IO-Link Configurator is standalone commissioning, configuration and management software for the WAGO Field I/O System's IO-Link Master and Hubs.

It supports all IO-Link devices per the IO-Link specification and allows automatic download of IODDs via integrated IODD Finder.

Register now and test our engineering software for 30 days at no cost.

Runtime Software

Firmware

IO-Field 765-17xx Firmware Download	01	zip 340.6 kB	Download
-------------------------------------	----	-----------------	--------------------------

CAD files

CAD data

2D/3D Models 765-1705/200-000		URL	Download
-------------------------------	--	-----	--------------------------

CAE data

ZUKEN Portal 765-1705/200-000		URL	Download
-------------------------------	--	-----	--------------------------

Environmental Product Compliance

Compliance Search

Environmental Product Compliance 765-1705/200-000 8-channel digital input/output; IO Link Class B Hub; DC 24 V / 2.0 A; 8xM8 connection; HubLine		URL	Download
--	--	-----	--------------------------

Installation Notes

Product family

I/O System Field
[Show all products from the family](#)

Subject to changes. Please also observe the further product documentation!

WAGO Corporation
Germantown, WI 53022
Phone: 1-800-DIN-RAIL (346-7245) | Fax: (262) 255-6222
Email: info.us@wago.com | Web: www.wago.us

Do you have any questions about our products?
We are always happy to take your call at (262) 255-6222 or 1 800-DIN-RAIL.